



Series 300 CE

Mortice locks for
timber and steel
doors

Table of contents



03	Mortice Lock 300 Benefits / Features
04	Mortice Lock 300 Classification EN 12209 / Lock details
05	Mortice Lock 300 Handing
06	Mortice Lock 300 Application
06	Mortice Lock 300 Summary
08	Mortice Lock 300 CE Lock Range
15	Lock Article Numbers

**Figure: dormakaba lock series 300
dormakaba lever handle OGRO**

dormakaba Mortice locks for timber and steel doors

- a complete range of high quality products

dormakaba locks offer the very highest standard of quality and functional reliability. With the use of high-grade materials, precise production techniques and a comprehensive quality management system, all dormakaba locks meet demanding technical specifications. Additionally, locks conforming to the technical requirements of DIN 18251 and EN 12209 also offer unbeatable ease of use and security features. Locks are supplied complete with fixing screws, strike plate and dust box.

Benefits at a glance

For the architect

- The high quality satin stainless steel surface finish satisfies very high demands with respect to the appearance of the door furniture.

For the trade

- The package contains the Mortice lock with screws and strike plate
- Non-handed lock version to reduce storage space
- Identical fixing screws for lock and strike plate simplify material management
- Having been assigned category of use grade 3 per EN 12209 the locks can also be reliably installed in buildings subject to heavy pedestrian traffic frequencies
- Successfully completed in-house testing to 1,000,000 cycles.
- dormakaba Mortice locks have following variations:

backset	60 mm
	80 mm
forend- square	20 mm
rounded	20 mm
square	24 mm
rounded	24 mm

For the installer

- dormakaba locks offer their precision by a simple, compatible assembling in standard door cuts.
- dormakaba locks have consistently uniform sizes each and are interchangeable.
- dormakaba locks can be used universally by changing the latch handing, without using a tool.
- dormakaba locks achieve a long life because of a robust maintenance-free lock mechanism, even under difficult operating conditions.
- dormakaba locks can be commonly used with standard fittings, e.g. standard lever handles, profile cylinders, roses/escutcheons/backplates etc.
- dormakaba locks are subject to strict quality requirements and are tested and certified according to EN 12209. For applications with increased security requirements the locks are tested and certified in accordance with national and international standards.
- dormakaba locks are fire tested and Certifire approved - CF 267 (applies to 300 CE locks with 20mm forends only).
- Intumescent packs are required for FD60/E60/EI60 - Please refer to Certifire CF267 or the Door Manufacturer's fire test evidence for the use of intumescent material on other door types.

Features	300 CE Premier
Grade EN 12209	3
CE	x
DIN 18251-1	x
Door Application for:	Public
Latch handing	Reversible (391, 392, & 393 locks are handed)
Latch	Satin stainless steel
Follower 8 mm	Clamp
Follower bearing	Steel bushes
Dead bolt	Satin stainless steel
Anti-saw protection	x
Anti-picking shield	x
Fixing holes	Bushed
Forend	Screwed
Forend SSS	AISI 316g
Fire Rated & Certifire approved	x

x yes - no

Lock details

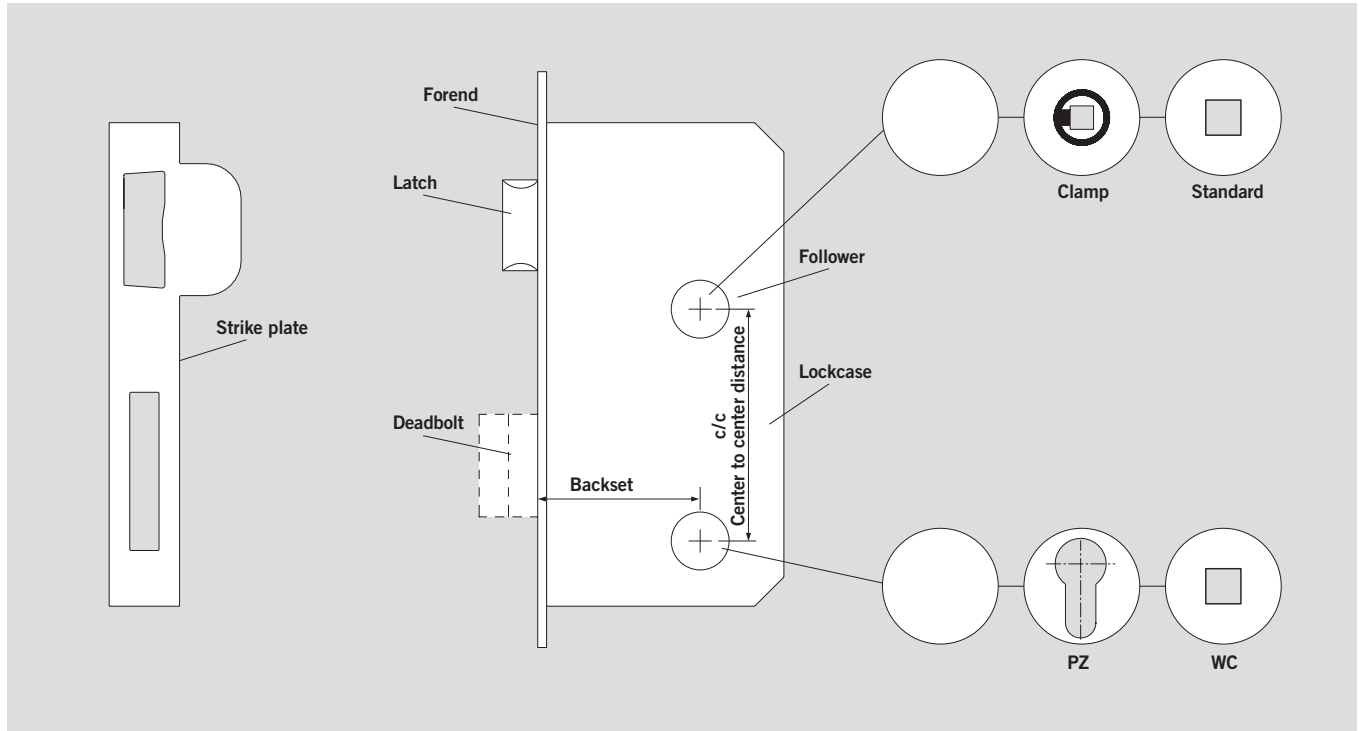

Example Classification code to EN 12209 for the 381 CE lock

Mortice locks 381	3	X	8	1	0	G	6	B	C	2	0
Category of use e.g. doors in public buildings											Key identification no requirement
Durability 200.000 cycl./120 N load on latch bolt											Type of spindle operation for unsprung lever handle
Door Mass up to 200kg, closing force 15 N											Key operation and locking Cylinder manually with intermediate
Fire / smoke doors approved											Door application Hinged door
Safety no requirements											Security-drill resistance very high security no drill resistance
											Corrosion resistance very high resistance, NSS 120 h, -20 °C to + 80 °C

Handing data for entrance door sets

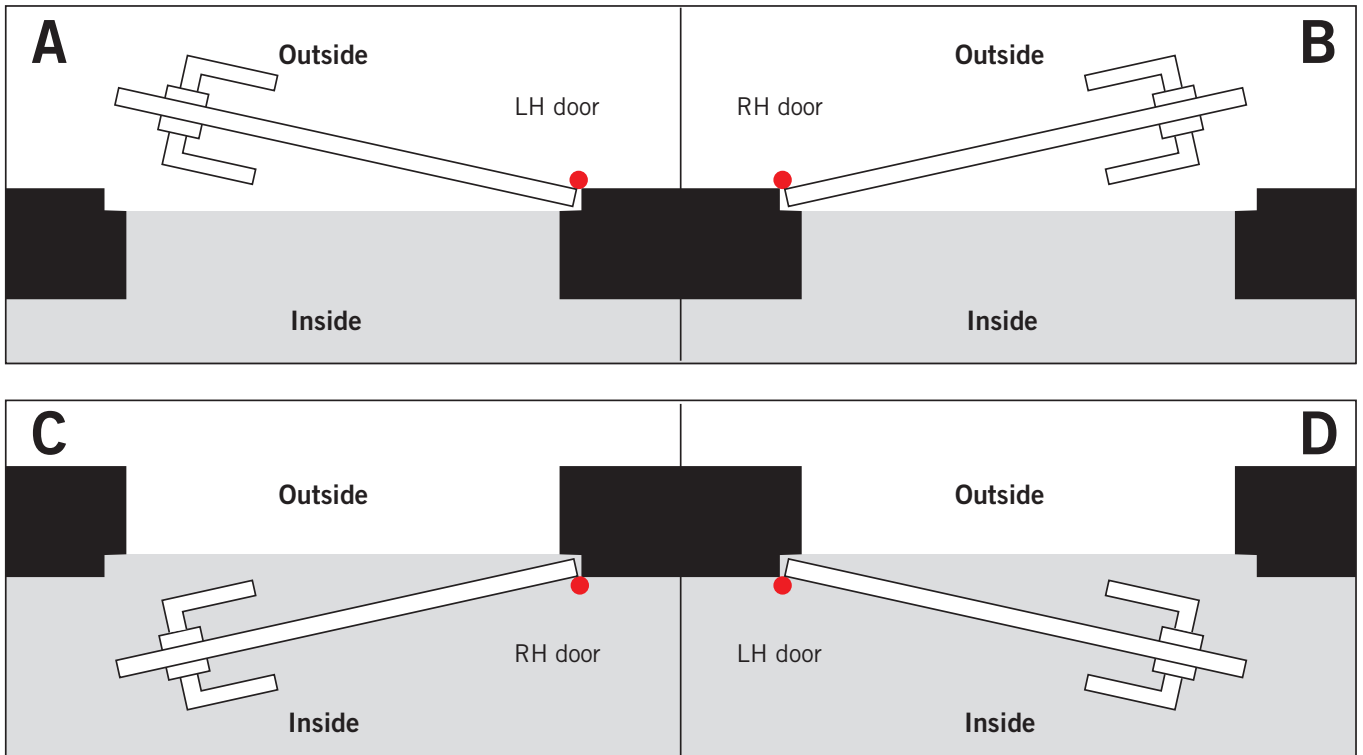

dormakaba locks are prepared to be used with the dormakaba OGRO and Pure ranges.



Projects with high demands on function and design.

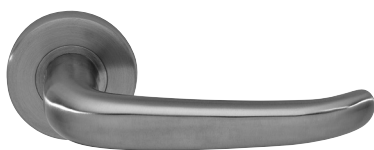

PREMIER series 300 CE		381	385	388	389	391	392	393
Latch type standard		x	x	-	x	antithrust	antithrust	classroom
Latch retractable	by handle	x	x	-	x	x	x	x
	by cylinder	x	-	-	-	x	x	x
Dead bolt	double throw 20 mm	x	-	x	-	x	-	-
	single throw 10 mm	-	x	-	-	-	-	-
Dead bolt operable by cylinder EPC		x	-	x	-	x	-	-
	by thumbturn	-	x	-	-	-	-	-
Centers	72 mm	x	-	x	x	x	x	x
	78 mm	-	x	-	-	-	-	-
Backset		60-80	60-80	60-80	60-80	60	60	60
Forend	20 mm rounded / square	x / x	x / x	x / x	x / x	x / x	x / x	x / x
	24 mm rounded / square	x / x	x / x	x / x	x / x	x / x	x / x	- / -
More information on page:		8	9	10	11	12	13	14

x yes - no

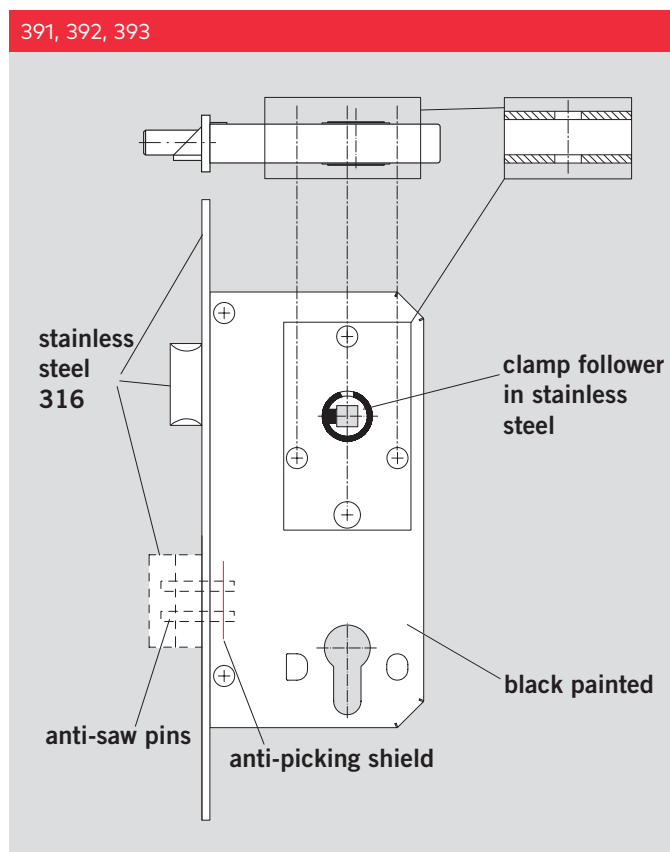
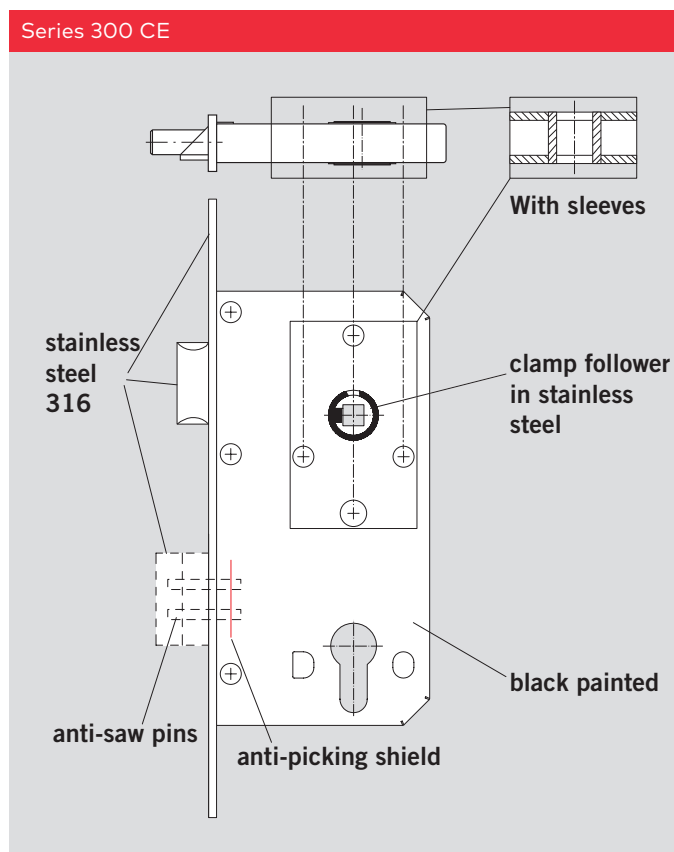

Mortice Locks

Series 300 CE, 391, 392, 393



Mortice Sashlock 381

Locks for interior and exterior doors, e.g. in public buildings

Features

Grade 3 – EN 12209, approved for fire-rated doors with CE certificate and CERTIFIRE Approved CF 267*

- Lock case size DIN 18251-1, closed case with sleeves, zinc plated, black painted
- Lock case prepared for Euro profile cylinder (DIN18252) and standard fittings
- Latch handing is reversible
- Latch and dead bolt, stainless steel, satin
- Security dead bolt with hardened anti-saw pins, anti-picking shield
- Clamp follower, stainless steel, 8 mm square hole, with separate bush bearing
- Centered forend, satin stainless steel 1.4401 / AISI 316

Side: non-handed

* CF 267 applies to locks with 20mm forends only.

Classification EN 12209

3	X	8	1	0	G	6	B	C	2	0
---	---	---	---	---	---	---	---	---	---	---

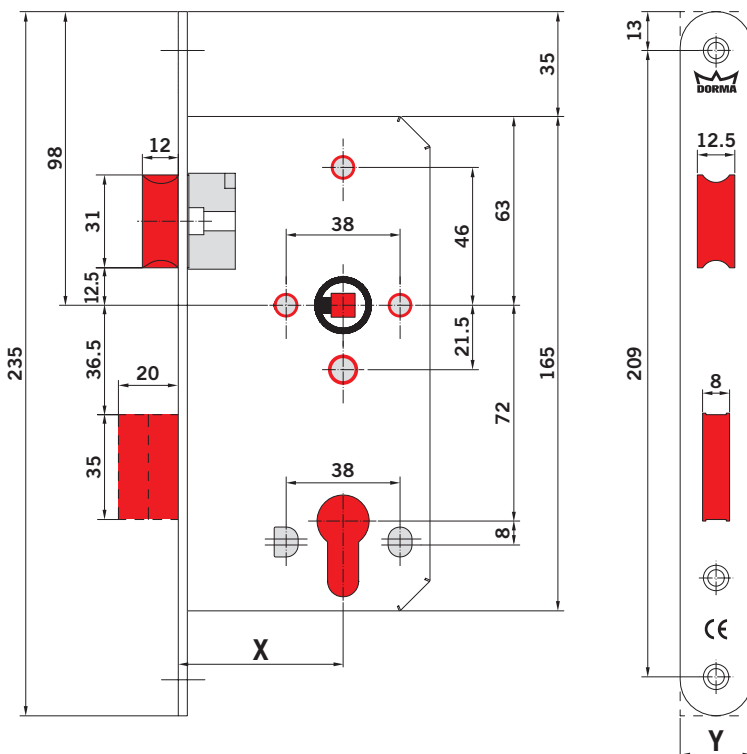
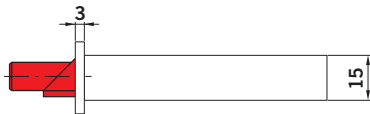

Possible variation

Backset: X

60mm

80mm lock only in 20 mm forend

Dimension of forend: Y

Square 20mm

24mm

Rounded 20mm

24mm



dormakaba locks are prepared for use with the dormakaba lever handles

Mortise WC Lock 385

Locks for bathroom doors, e.g. in public buildings

Features

Grade 3 – EN 12209, approved for fire-rated doors with CE certificate and CERTIFIRE Approved CF 267*

- Lock case size DIN 18251-1, closed case with sleeves, zinc plated, black painted
- Lock case prepared for thumbturn and standard fittings
- Latch handing is reversible
- Latch and dead bolt, stainless steel, satin
- Security dead bolt with hardened anti-saw pins, anti-picking shield
- Clamp follower, stainless steel, 8 mm square hole, with separate bush bearing and 8 mm bathroom follower
- Centered forend, satin stainless steel 1.4401 / AISI 316

Side: non-handed

* CF 267 applies to locks with 20mm forends only.

Classification EN 12209

3	X	8	1	0	G	6	B	G	2	0
---	---	---	---	---	---	---	---	---	---	---

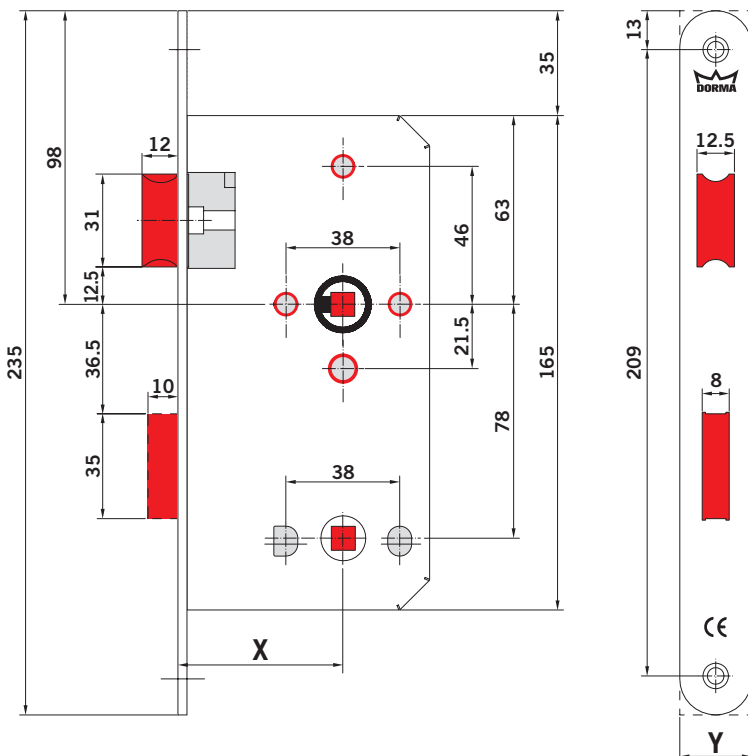
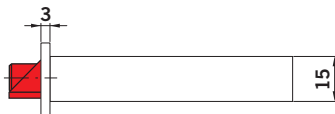

Possible variation

Backset: X

60mm

80mm lock only in 20mm forend

Dimension of forend: Y

Square 20mm

24mm

Rounded 20mm

24mm



dormakaba locks are prepared for use with the dormakaba lever handles

Mortice Deadlock 388

Locks for interior and exterior doors, e.g. in public buildings

Features

Grade 3 – EN 12209, approved for fire-rated doors with CE certificate and CERTIFIRE Approved CF 267*

- Lock case size DIN 18251-1, closed case with sleeves, zinc plated, black painted
- Lock case prepared for Euro profile cylinder (DIN18252) and standard fittings
- Dead bolt, stainless steel, satin
- Security dead bolt with hardened anti-saw pins, anti-picking shield
- Centered forend, satin stainless steel 1.4401 / AISI 316

Side: non-handed

* CF 267 applies to locks with 20mm forends only.



Classification EN 12209

3	X	8	1	0	G	6	B	C	0	0
---	---	---	---	---	---	---	---	---	---	---

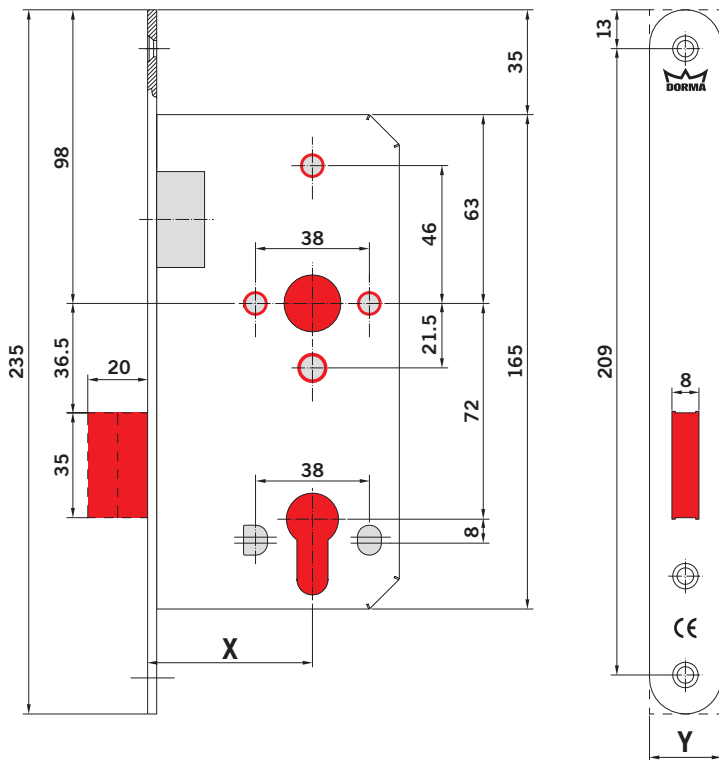
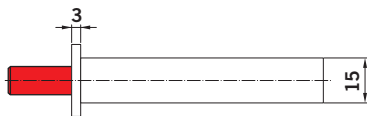

Possible variation

Backset: X

60mm

80mm lock only in 20mm forend

Dimension of forend: Y

Square 20mm

24mm

Rounded 20mm

24mm

Mortise Latch 389

Locks for interior and exterior, e.g. in public buildings

Features

Grade 3 – EN 12209, approved for fire-rated doors with CE certificate and CERTIFIRE Approved CF 267*

- Lock case size DIN 18251-1, closed case with sleeves, zinc plated, black painted
- Lock case prepared for standard fittings
- Latch handing is reversible
- Latch, stainless steel, satin
- Clamp follower, stainless steel, 8 mm square hole, with separate bush bearing
- Centered forend, satin stainless steel 1.4401 / AISI 316

Side: non-handed

* CF 267 applies to locks with 20mm forends only.

Classification EN 12209

3	X	8	1	0	G	-	B	0	2	0
---	---	---	---	---	---	---	---	---	---	---

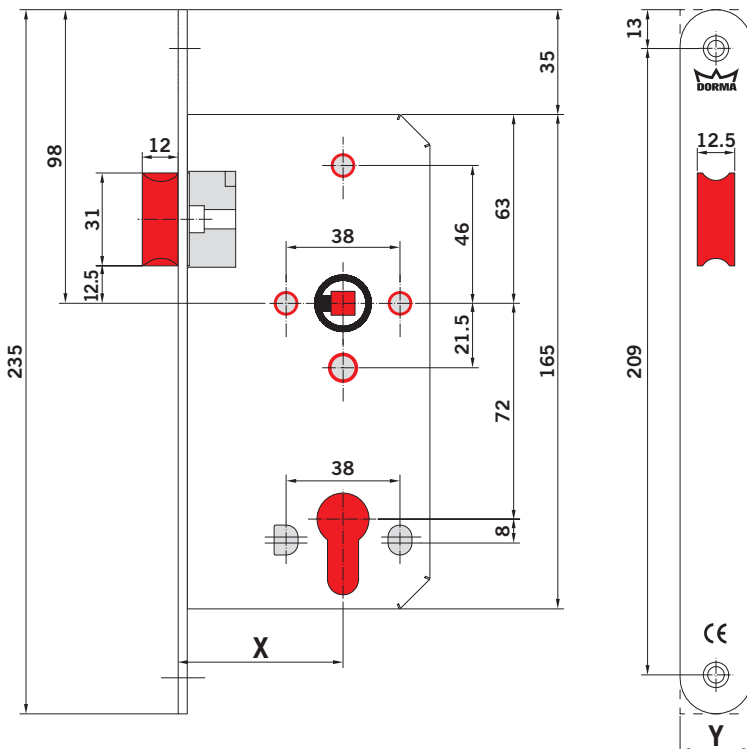
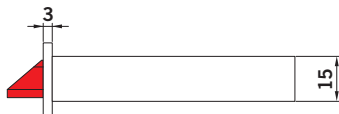

Possible variation

Backset: X

60mm

80mm lock only in 20mm forend

Dimension of forend: Y

Square 20mm

24mm

Rounded 20mm

24mm



dormakaba locks are prepared for use with the dormakaba lever handles

Mortice Anti-Thrust Sashlock 391

Locks for interior and exterior doors, e.g. in public buildings

Features

Grade 3 – EN 12209, approved for fire-rated doors with CE certificate and CERTIFIRE Approved CF 267*

- Lock case size DIN 18251-1, closed case, zinc plated, black painted
- Lock case prepared for Euro profile cylinder (DIN18252) and standard fittings
- Left & right handed variants
- Anti-thrust latch, with snib
- Latch and dead bolt, stainless steel, satin
- Security dead bolt with hardened anti-saw pins, anti-picking shield
- Follower, stainless steel, 8 mm square hole, mounted in drawn steel bushes
- Centered forend, satin stainless steel 1.4401 / AISI 316

* CF 267 applies to locks with 20mm forends only.

Classification EN 12209

3	S	8	1	0	G	6	B	C	2	0
---	---	---	---	---	---	---	---	---	---	---

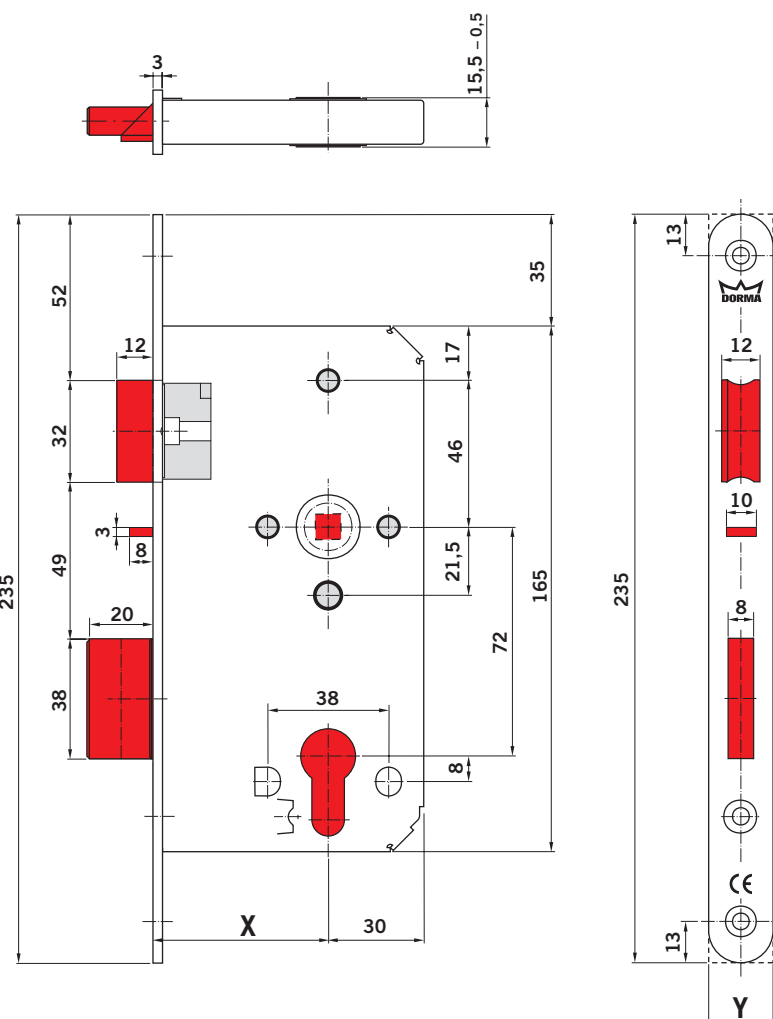

Possible variation

Backset: X

60mm

Dimension of forend: Y

Square 20mm

24mm

Rounded 20mm

24mm



dormakaba locks are prepared for use with the dormakaba lever handles

Mortice Night Latch 392

Locks for interior and exterior doors, e.g. in project buildings

Features

Grade 3 – EN 12209, approved for fire-rated doors with CE certificate and CERTIFIRE Approved CF 267*

- Lock case size DIN 18251-1, closed case, zinc plated, black painted
- Lock case prepared for Euro profile cylinder (DIN18252) and standard fittings
- Left & right hand variants
- Anti-thrust latch with snib
- Latch, stainless steel, satin
- Follower, stainless steel, 8 mm square hole, mounted in drawn steel bushes
- Centered forend, satin stainless steel 1.4401 / AISI 316

* CF 267 applies to locks with 20mm forends only.

Classification EN 12209

3	S	8	1	0	G	3	B	0	2	0
---	---	---	---	---	---	---	---	---	---	---

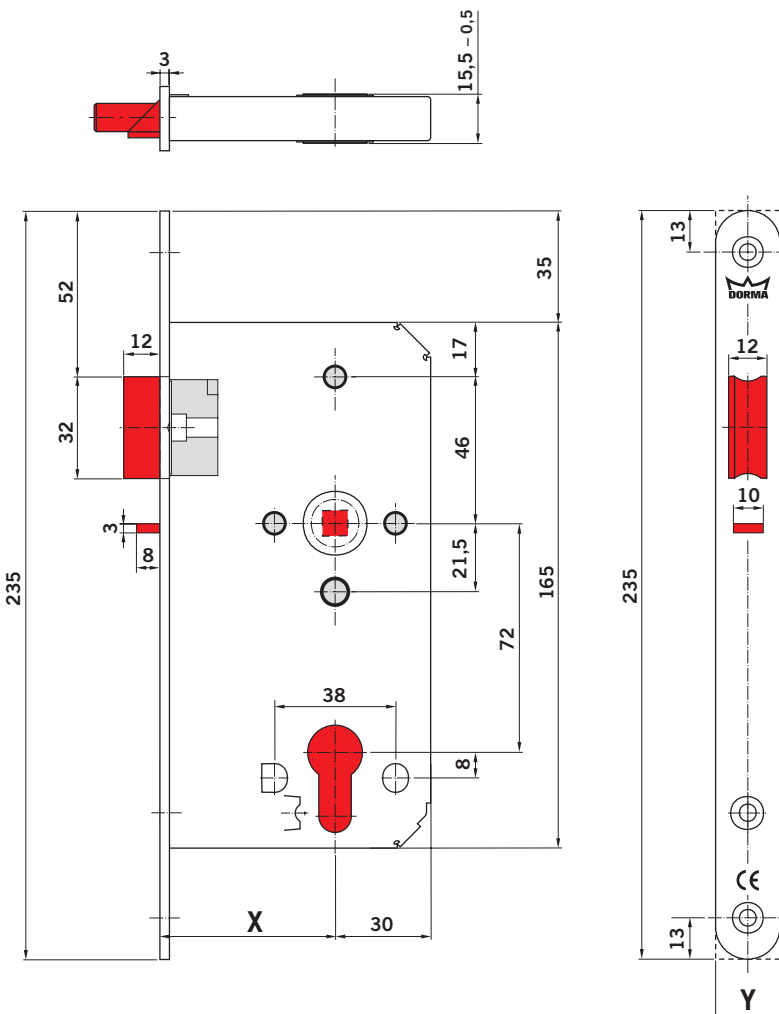

Possible variation

Backset: X

60mm

Dimension of forend: Y

Square 20mm

24mm

Rounded 20mm

24mm



dormakaba locks are prepared for use with the dormakaba lever handles

Mortice Lock 393

Locks for classroom doors

Features

Grade 3 – EN 12209, approved for fire-rated doors with CE certificate and CERTIFIRE Approved CF 267

- Lock case size DIN 18251-1, closed case, zinc plated, black painted
- Lock case prepared for Euro profile cylinder (DIN18252) and standard fittings
- Left & right hand variants
- For outward opening doors
- Anti-thrust latch with snib
- Latch, stainless steel, satin
- Split follower, stainless steel, 8 mm square hole, mounted in drawn steel bushes, outside follower, lockable by cylinder
- Centered forend, satin stainless steel 1.4401 / AISI 316
- Delivered with split spindle (8 x 110 mm)

Classification EN 12209

3	S	8	1	0	G	3	B	0	2	0
---	---	---	---	---	---	---	---	---	---	---

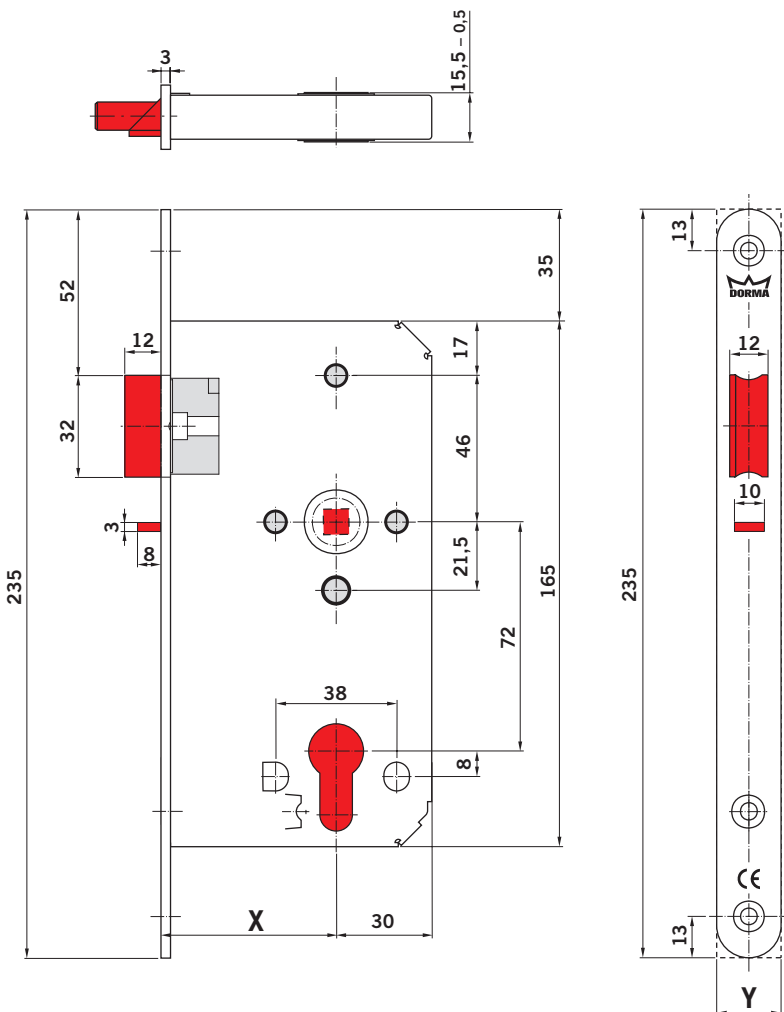

Possible variation

Backset: X

60mm

Dimension of forend: Y

Square 20mm

Rounded 20mm



dormakaba locks are prepared for use with the dormakaba lever handles

300 CE Lock Article Number List

300 CE LOCKS	
381 CE SASHLOCK	SQUARE FOREND/SQUARE STRIKEPLATE
51310185	381CE A PREM S/LOCK 60MM 20MM SQFE SQSP
51310187	381CE A PREM S/LOCK 60MM 24MM SQFE SQSP
51310197	381CE A PREM S/LOCK 80MM 20MM SQFE SQSP
	RADIUS FOREND/RADIUS STRIKEPLATE
51310403	381CE B PREM S/LOCK 60MM 20MM RDFE RDSP
51310404	381CE B PREM S/LOCK 60MM 24MM RDFE RDSP
51310463	381CE B PREM S/LOCK 80MM 20MM RDFE RDSP
385 CE BATHROOM WC LOCK	SQUARE FOREND/SQUARE STRIKEPLATE
51310225	385CE A PREM WC 60MM 20MM SQFE SQSP
51310227	385CE A PREM WC 60MM 24MM SQFE SQSP
51310237	385CE A PREM WC 80MM 20MM SQFE SQSP
	RADIUS FOREND/RADIUS STRIKEPLATE
51310407	385CE B PREM WC 60MM 20MM RDFE RDSP
51310408	385CE B PREM WC 60MM 24MM RDFE RDSP
51310467	385CE B PREM WC 80MM 20MM RDFE RDSP
388 CE DEADBOLT	SQUARE FOREND/SQUARE STRIKEPLATE
51310265	388CE A PREM D/LOCK 60MM 20MM SQFE SQSP
51310267	388CE A PREM D/LOCK 60MM 24MM SQFE SQSP
51310277	388CE A PREM D/LOCK 80MM 20MM SQFE SQSP
	RADIUS FOREND/RADIUS STRIKEPLATE
51310411	388CE B PREM D/LOCK 60MM 20MM RDFE RDSP
51310412	388CE B PREM D/LOCK 60MM 24MM RDFE RDSP
51310471	388CE A PREM D/LOCK 80MM 20MM RDFE RDSP
389 CE LATCH	SQUARE FOREND/SQUARE STRIKEPLATE
51310305	389CE A PREM LATCH 60MM 20MM SQFE SQSP
51310307	389CE A PREM LATCH 60MM 24MM SQFE SQSP
51310317	389CE A PREM LATCH 80MM 20MM SQFE SQSP
	RADIUS FOREND/RADIUS STRIKEPLATE
51310415	389CE B PREM LATCH 60MM 20MM RDFE RDSP
51310416	389CE B PREM LATCH 60MM 24MM RDFE RDSP
51310475	389CE B PREM LATCH 80MM 20MM RDFE RDSP
391 CE ANTI THRUST SASHLOCK	SQUARE FOREND/SQUARE STRIKEPLATE
51310325	391CE A PREM S/L 60MM 20MM SQFE SQSP RH
51310485	391CE A PREM S/L 60MM 20MM SQFE SQSP LH
51310327	391CE A PREM S/L 60MM 24MM SQFE SQSP RH
51310486	391CE A PREM S/L 60MM 24MM SQFE SQSP LH
	RADIUS FOREND/RADIUS STRIKEPLATE
51310419	391CE B PREM S/L 60MM 20MM RDFE RDSP RH
51310480	391CE B PREM S/L 60MM 20MM RDFE RDSP LH
51310420	391CE B PREM S/L 60MM 24MM RDFE RDSP RH
51310481	391CE B PREM S/L 60MM 24MM RDFE RDSP LH
392 CE ANTI THRUST NIGHTLATCH	SQUARE FOREND/SQUARE STRIKEPLATE
51310345	392CE A PREM N/L 60MM 20MM SQFE SQSP RH
51310487	392CE A PREM N/L 60MM 20MM SQFE SQSP LH
51310347	392CE A PREM N/L 60MM 24MM SQFE SQSP RH
51310488	392CE A PREM N/L 60MM 24MM SQFE SQSP LH
	RADIUS FOREND/RADIUS STRIKEPLATE
51310423	392CE B PREM N/L 60MM 20MM RDFE RDSP RH
51310482	392CE B PREM N/L 60MM 20MM RDFE RDSP LH
51310424	392CE B PREM N/L 60MM 24MM RDFE RDSP RH
51310483	392CE B PREM N/L 60MM 24MM RDFE RDSP LH
393 CE CLASSROOM	SQUARE FOREND/SQUARE STRIKEPLATE
51310489	393CE A PREM C/L 60MM 20MM SQFE SQSP RH
51310490	393CE A PREM C/L 60MM 20MM SQFE SQSP LH
	RADIUS FOREND/RADIUS STRIKEPLATE
51310484	393CE B PREM C/L 60MM 20MM RDFE RDSP RH
51310427	393CE B PREM C/L 60MM 20MM RDFE RDSP LH
403000060	INTUMESCENT PACK FOR 60MM LOCKS
403000080	INTUMESCENT PACK FOR 80MM LOCKS

Our products

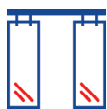

Interior Glass Systems

System solutions made from glass for a wide range of everyday and office applications



Mechanical Key Systems

Systems that enable access rights and key control to all rooms within the premises



Lodging Systems

Hotel locks and locking systems as well as access management solutions for holiday homes



Electronic Access & Data

Electronic access control and workforce management for efficient access management, security and data collection



Entrance Systems

Automated access solutions for convenient access to buildings



Door Hardware

Solutions for residential or commercial projects



Safe Locks

Security locks for preventing unauthorized access to goods, valuables, information or hazardous substances



Services

Tailor-made services and customized maintenance for long-term functional integrity of access and security solutions

