



KTC 2

Safety and comfort combined in a sophisticated entrance system

The entrance area is the showcase of a building. No other component makes such a lasting first impression on visitors or complements the facade so effectively. High requirements therefore have to be placed on the visual quality of a door system, on its design and functionality.

The KTC 2 two-wing revolving door system offers plenty of scope for architectural creativity. Thanks to the variability of its design and a broad selection of surface finishes, it will enhance the entrance of any building, giving it both uniqueness and style. Easy to operate and suited to the requirements of wheelchair users, the

KTC 2 also raises accessibility and convenience to a new level.

The wide range of functions ensures high traffic capacities even during peak traffic periods, plus unbeatable safety. And there are major additional benefits to be had from the suitability of these doors as advertising space. It is furthermore important for the economic operation of a building to provide effective protection of its interior against cold, heat, strong draft, noise and dust.

The two-wing revolving door KTC 2 comprehensively supports these requirements and is available in 4 standard sizes with an integrated passage door. Thanks to its integrated night shield and a wide range of optional accessories, it is suitable for a variety of applications.



Twice as convenient thanks to its integrated automatic sliding door

This intelligent revolving door with its automatic sliding door – integrated in the system's turnstile – will convince both the facility operator and the user of its various benefits.

Revolving door system for average traffic capacities

During everyday business, the KTC 2 optimizes user traffic and at the same time reliably protects from external influences.

Special brush seals help to create a sensible climate barrier between the interior and the exterior of the building. This feature helps to reduce heating or air conditioning costs, while the low energy consumption of the drive motor is a further benefit that should not be forgotten.

Sliding door for heavy user traffic

Whenever a large number of guests use the door or bulky items have to be carried through the door system, the automatic sliding door, which is integrated in the system's turnstile, provides maximum convenience.

Using the well established dormakaba ES 200 sliding door technology ensures reliable operation and high user comfort.



Dimensions, Options

Specifications and functional characteristics				
Internal diameter (D) in mm	3600	4200	4800	5400
Door set, powder coated, width (B) in mm	3841	4441	5041	5641
Door set, cladded, width (B) in mm	3846	4446	5046	5646
External diameter drum wall (B1) in mm	3664	4264	4864	5464
External diameter canopy (B2) in mm	3820	4420	5020	5620
Passage width, revolving door (LW) in mm		1946	2246	2546
Passage width, sliding door (DW) in mm	1618	1918	2218	2518
People per section ¹⁾	3	5	7	9
Users per hour ¹⁾	1400	2000	2500	2900
Clear passage height (LH) in mm depending on system diameter	2100 – 3000 ²⁾			
Canopy height (SH) in mm	300 – 700 ³⁾			
System height (H) in mm	Clear passage height + canopy height			
Glazed drum walls	●			
Drum walls with metal panelling	○			
Prepared for rain-proof ceiling	○			
Winter configuration	○			
Floor ring	○			
Floor mat	○			
Downlights, 6 pcs.	●			
Type approval to DIN 18650 and EN 16005 (certified)	○			

● standard ○ option

¹⁾ User capacity when the revolving door is entered in both directions under standard conditions

²⁾ See "Maximum clear passage height for KTC 2"

³⁾ Higher canopy height on request

Benefits

- Spacious entrance
- Integrated automatic sliding door
- Easy passage of bulky items
- Suitable for disabled users
- Large sections
- Integrated night shield
- Showcases for advertising purposes
- With sliding door also available in 3600 + 4200 mm without showcases
- Highest safety standard
- Complete system manufactured with industrial precision and in assured quality

Maximum clear passage height for KTC 2

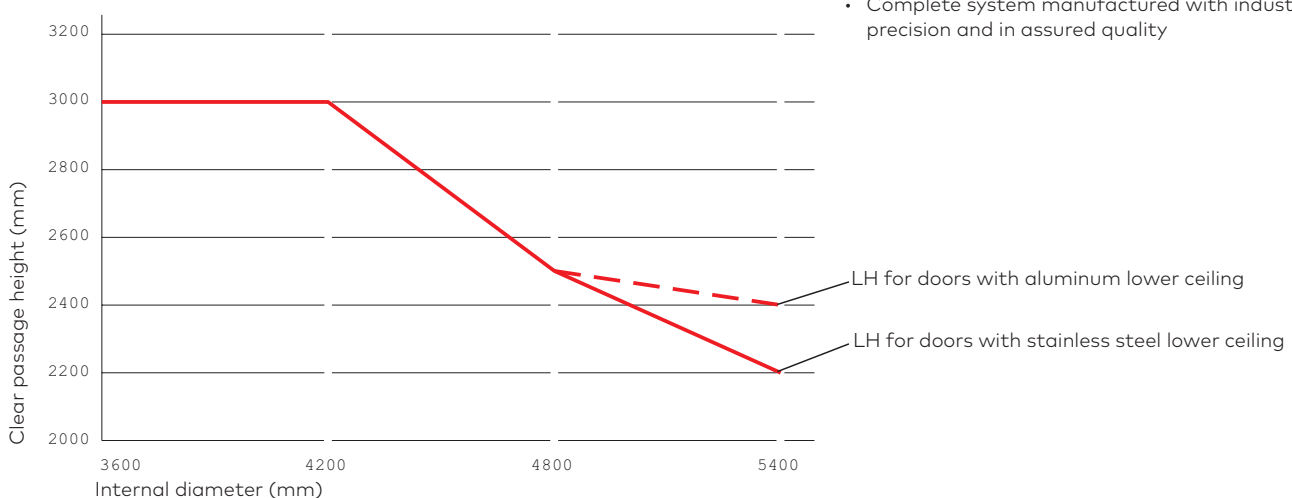

KTC 2/0 without showcases

- The two-wing revolving door system KTC 2/0 is available in 2 standard sizes (3600 & 4200 mm)
- The integrated night shield is equipped with 6.7 mm laminated safety glass
- The drum walls may either be glazed or supplied with metal panelling

KTC 2/2 with showcases

- The KTC 2/2 version is additionally supplied with 2 triangular showcases on the outside
- Max. load for showcases = 20 kg
- Available in all 4 sizes (3600, 4200, 4800 & 5400 mm)

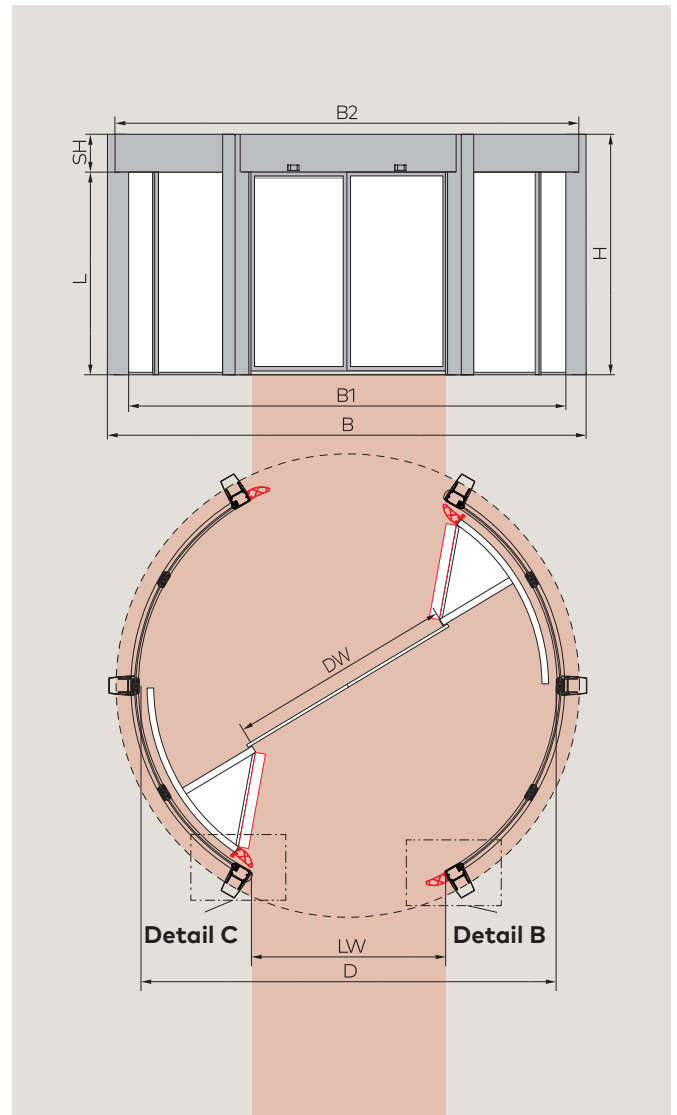
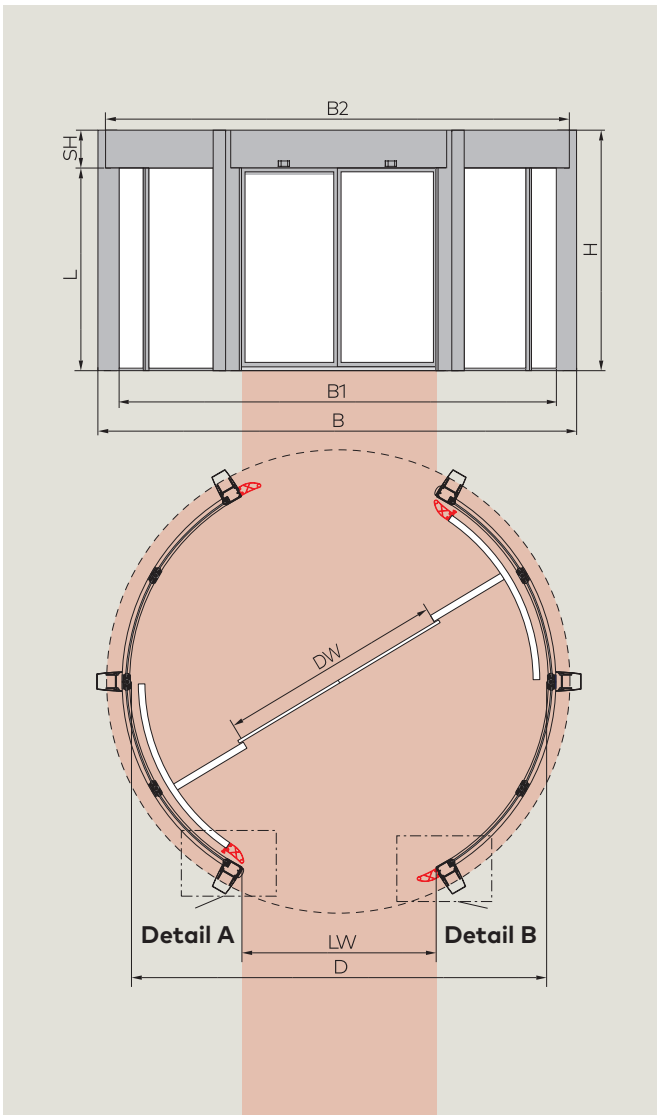

Detail A

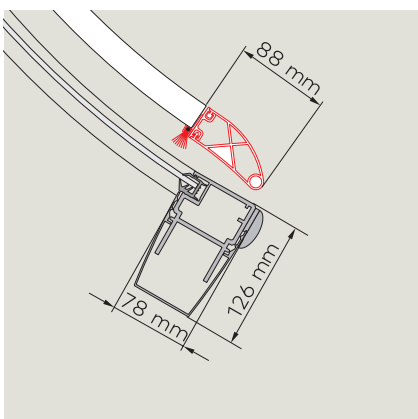

Detail B

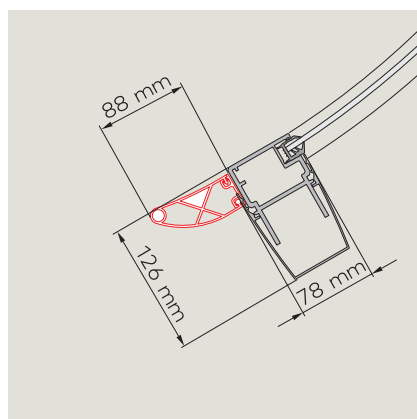

Detail C

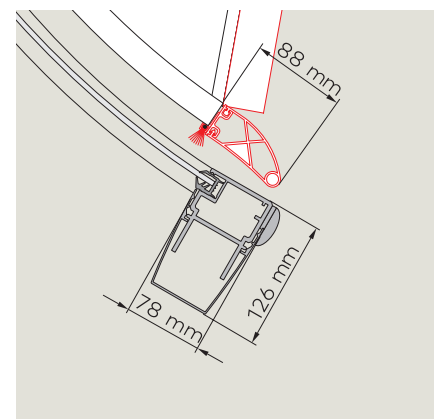

Versions, configurations

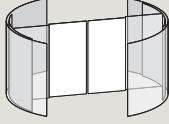
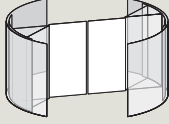
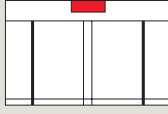
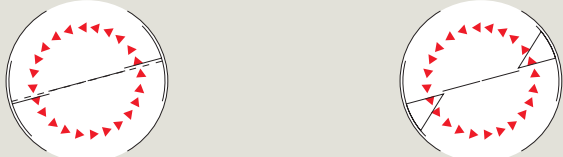
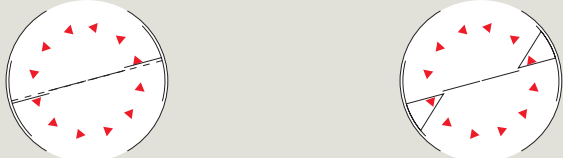
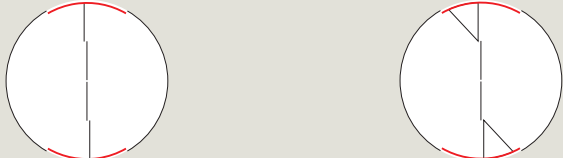
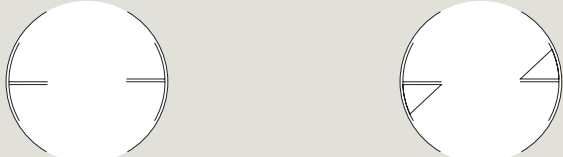
Versions	KTC 2/0 without showcases	KTC 2/2 with showcases
		
Operator types Canopy-integrated drive unit		
Automatic I: The door starts and stops automatically II: The door revolves permanently at low speed, which is increased as soon as a user approaches the door system		
Speed limiter , this feature limits the speed to approx. 1 rpm to suit the requirements of senior citizens and/or people with disabilities.		
Night shield Turnstile may be locked electrically and mechanically		
Summer configuration This configuration is also perfectly suitable for bulky items, luggage or consignment deliveries.		

Suitable for wheelchair users

In order to ensure convenient wheelchair access, various factors have to be considered.

The most important criterion is the size of the section. The drawings indicate the required space for the passage of a wheelchair user plus assistant. Please note that the manufacturer of the door system has only estimated the required dimensions for the wheelchair user plus assistant.

dormakaba would recommend door systems with a diameter of at least 4200 mm to ensure proper wheelchair access.

A further important aspect is the door speed. We must assume that the „disabled access pushbutton“ has been activated (before the users have entered the section) and that the speed has thus been reduced to approx. 1 rpm.

When planning your door system, please consider that the door has to be equipped with adequate optional safety equipment.

The individual safety equipment has to be agreed upon with the facility operator.

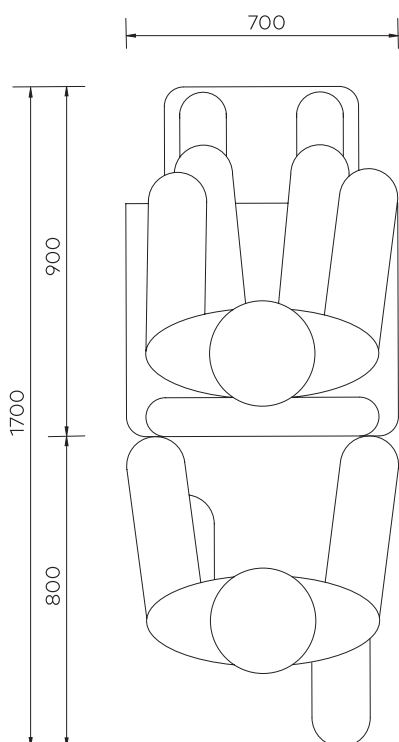

Diameter 3.6 m

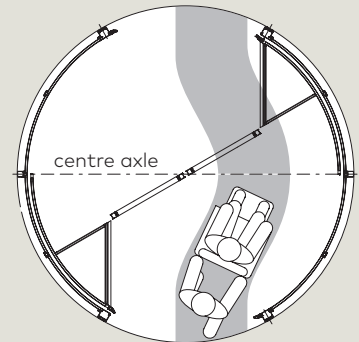

Diameter 4.2 m

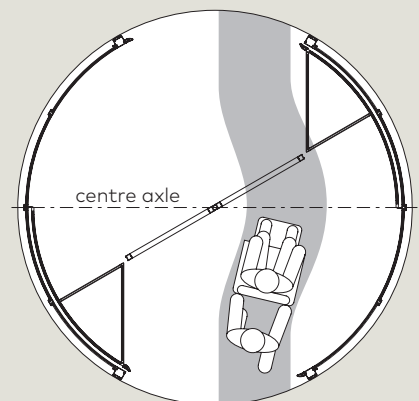

Diameter 4.8 m

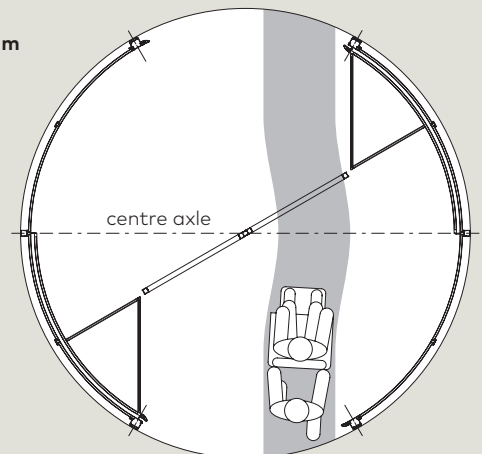

Diameter 5.4 m

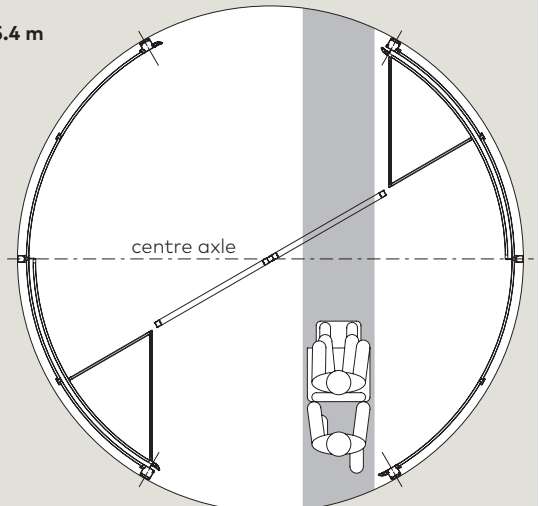

Floor rings

Dimensions

Overall size (internal diameter of door system)	3600	4200	4800	5400
Nominal radius (R)	1800	2100	2400	2700
Floor mat (C)	up to 30			

All dimensions in mm

Floor ring KTC 2

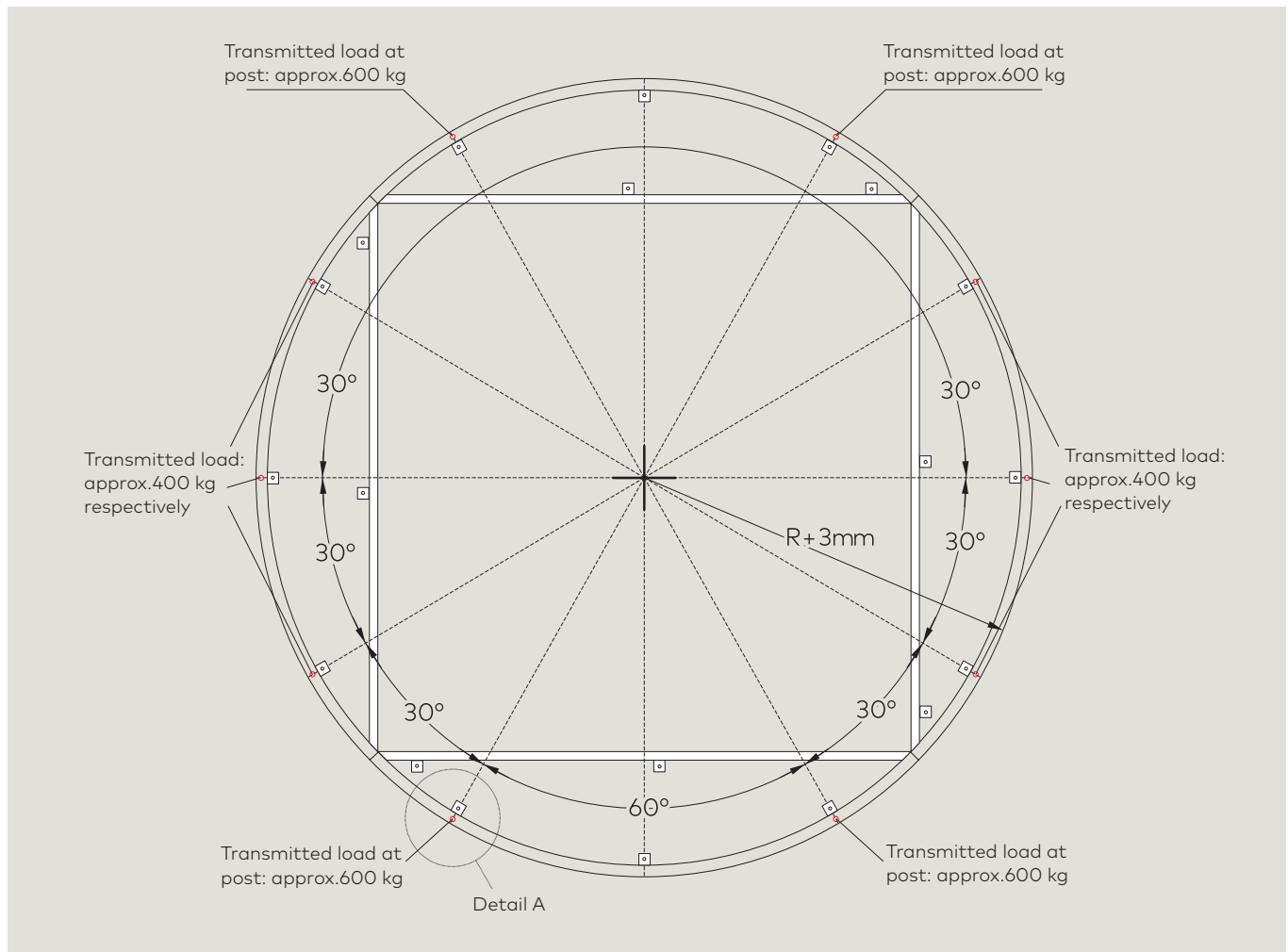

Detail A

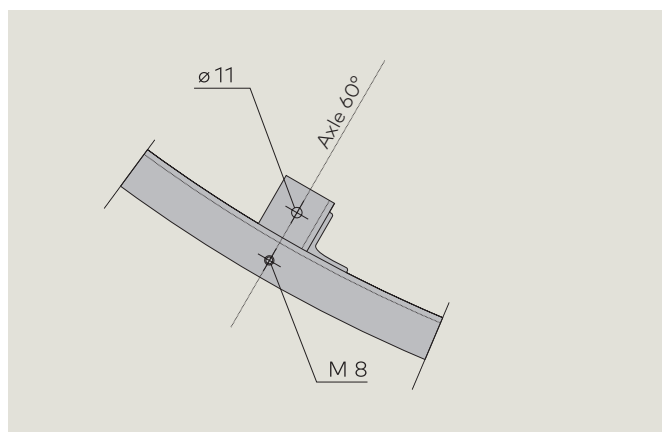

Cross section

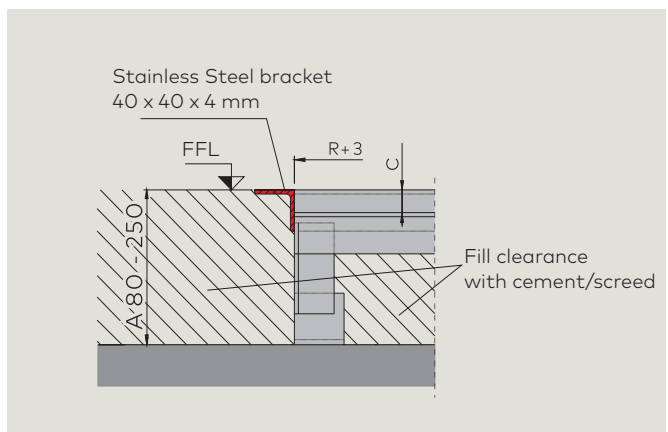

Integrated night shield

As soon as the respective function is activated via the program switch, the turnstile moves in order to create the night shield. The integrated night shield is designed to close both entrances of the revolving door.

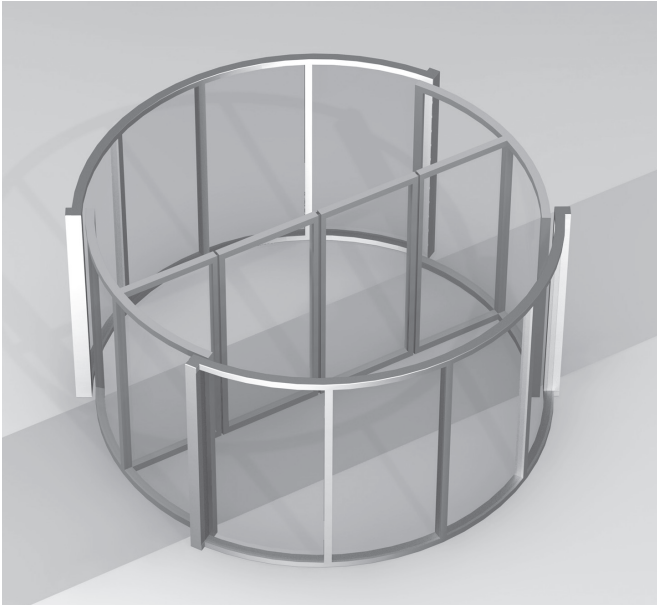

Smoke extraction function

Whenever an emergency signal is triggered, the turnstile will travel to the starting position (parallel to the facade axle). As soon as the turnstile has reached this position, the centre of the door opens automatically in order to create a ventilation opening for the smoke extraction of the building.

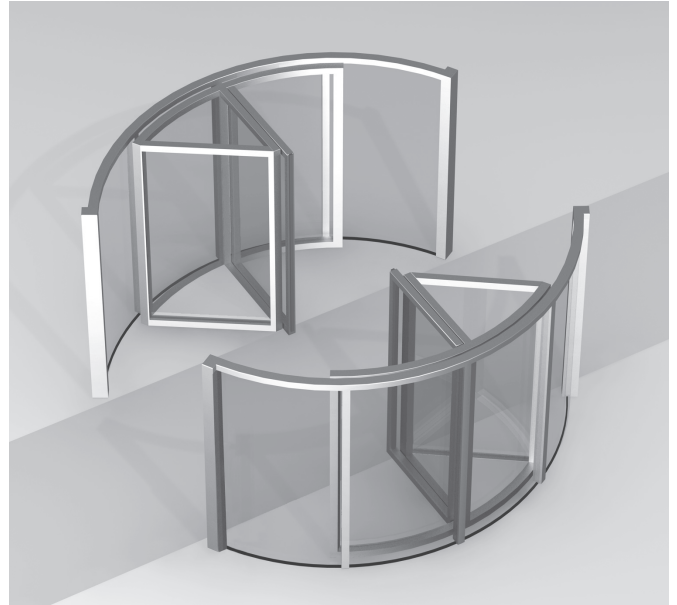

Wiring diagram

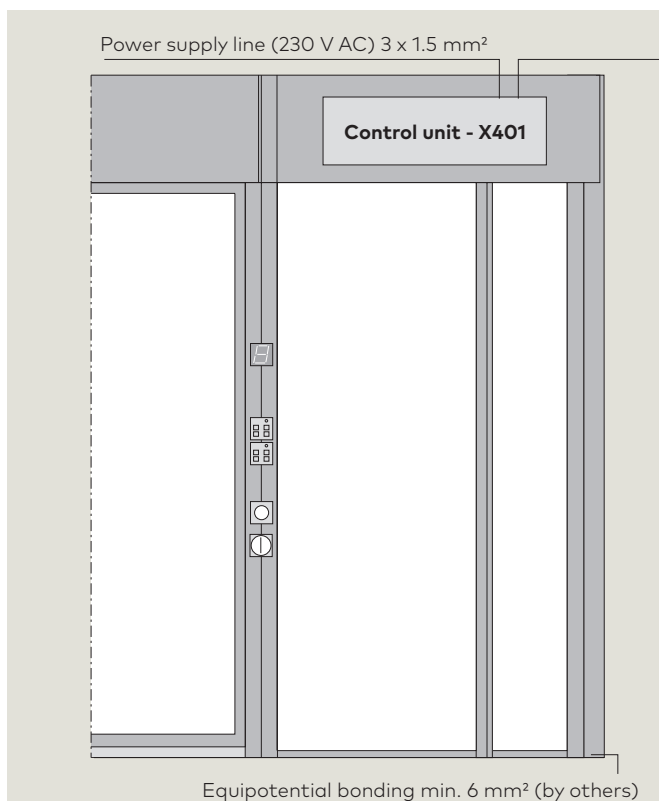

The following in-/outputs are available for external control elements:

- Input for "external emergency stop pushbutton"
- Output "walking speed"
- Output "low speed for disabled users"
- Output "positioning speed"
- Output "activated safety sensor"
- Input "winter configuration"
- Input "fire detection"
- Input "smoke extraction"

The power supply lines for the above-mentioned control elements have to be provided by others (2 x 0.75 mm² respectively).

Safety equipment

KTC 2 revolving doors offer a comprehensive range of safety equipment to ensure optimum protection of people and objects. The main closing edges are each equipped with infrared presence sensors and safety contact strips. As the showcase arrives at a point of less than 800 mm from the post profile, the infrared presence sensors are activated in addition to the safety contact strips. The horizontal outer edges of the night shield are likewise protected by safety contact strips. The sections are monitored with the aid of an infrared light curtain, which detects the presence of people or objects. Whenever people are moving too slowly for the revolving assembly, the operating speed will be reduced accordingly.

If a door wing meets an obstruction, the door is stopped until the obstruction has been removed. All safety functions are of redundant design. In addition, pre-detection sensors are integrated in the ceiling and positioned in front of the moving night shield.

Their detection range is located right in front of the main closing edge and reaches from the ceiling to short above the floor.

Automatic programs

The control unit allows the adjustment of 2 different automatic functions.

- **Automatic I:** The door does not move but is activated as soon as a user approaches the door system. After an adjustable period of time, the door will stop in its starting position.
- **Automatic II:** The door revolves permanently at a speed of approx. 1 rpm. The speed is increased to approx. 3 rpm whenever a user approaches the door and is decreased as soon as the user has left the door system.

Speed limiter

As soon as the speed limiter has been activated by pressing the disabled access pushbutton, the operation speed is decreased to approx. 1 - 2 rpm for an adjustable period of time. This allows disabled people to use the door system conveniently (for example by passing the door in a wheelchair).

Components	Function
1 Canopy safety sensor	Slow cycle / Stop
2 Safety bumper (leading mullion)	Stop
3 Active safety bumper (wing, bottom) ¹⁾	Stop
4 Active safety bumper (front edge of integrated night shield)	Stop
5 Emergency stop button (leading mullion)	Stop
6 Safety switch (showcase door)	Stop
7 Light barrier (wing, bottom)	Stop
8 Top sensor (wing/showcase, top)	Slow cycle / Stop
9 Pre-detection sensor (front edge of integrated night shield / lower ceiling)	Slow cycle / Stop
10 Disabled access pushbutton (leading mullion)	Slow cycle
11 Safety sensor and motion detector (automatic sliding door)	Stop

¹⁾ Not relevant for door systems without showcases

Please note

The safety equipment has to comply with the prevailing national guidelines.

Safety equipment for KTC 2 with automatic sliding door and without showcases

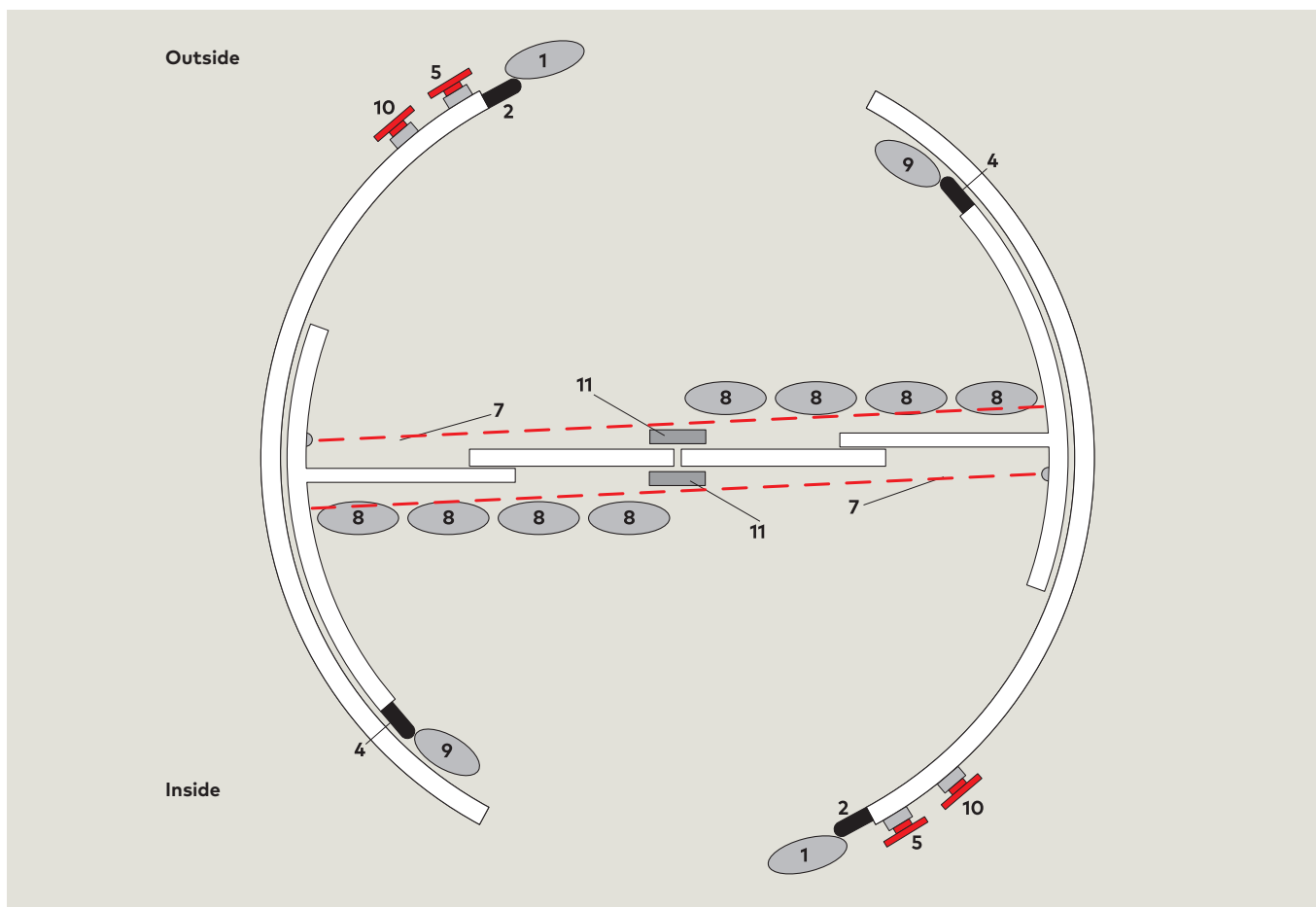

Safety equipment for KTC 2 with automatic sliding door and showcases

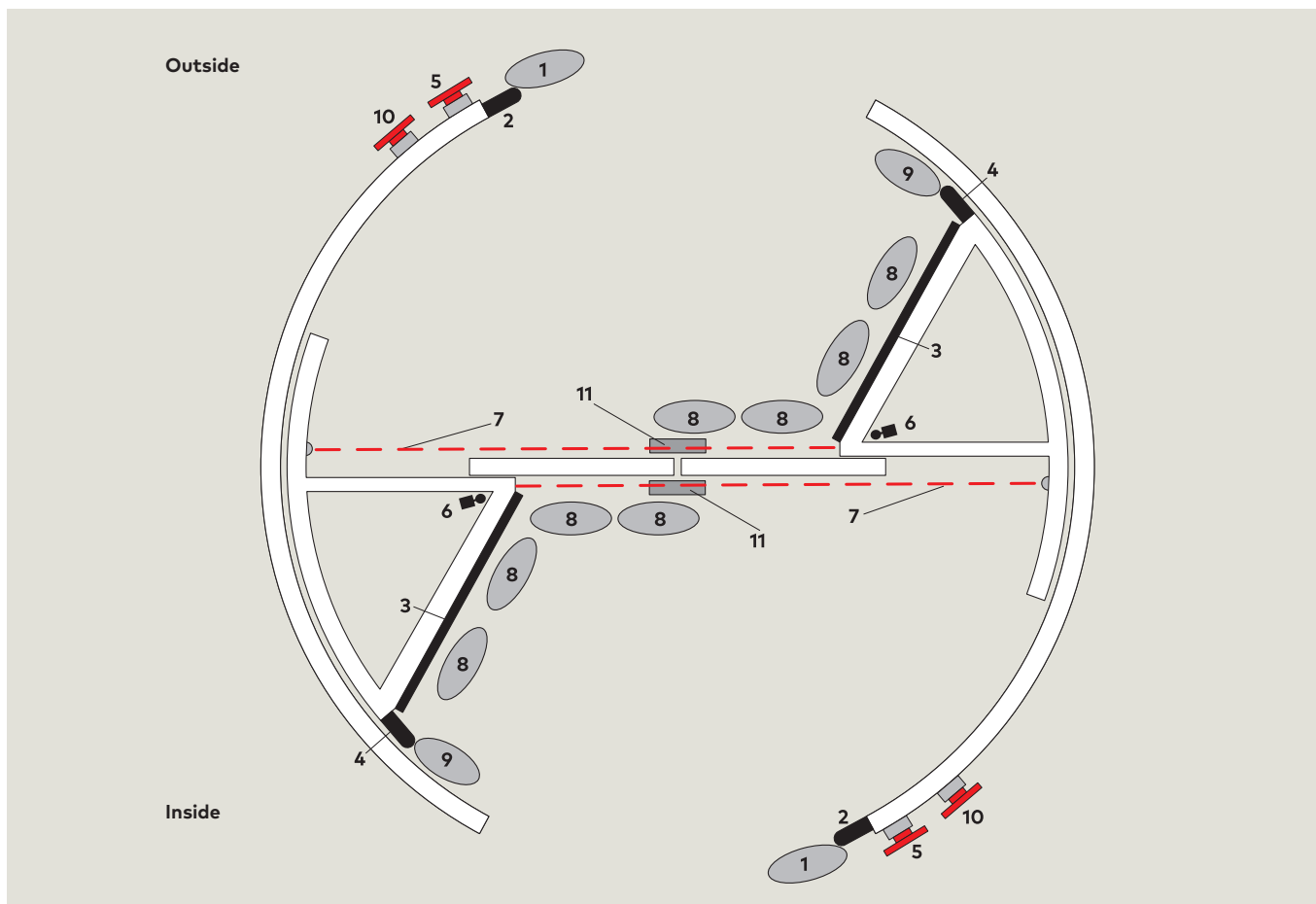

The complete solution

Automatic entrance systems require careful specification and installation to ensure safety and reliability in use. Commencing with a risk assessment survey, dormakaba will advise at all stages of design and installation so the correct methods of operation and user safety protection are adopted.

Risk Assessment

All automatic doors must be specified and installed following appropriate safety standards requiring risk assessment prior to installation and periodically during the life of the product. dormakaba are experienced with safety specification and can provide further details on request.

Professional and impartial advice from staff assessed and accredited by ADSA (Automatic Door Suppliers Association):

- Site surveys, escape routes, impaired user access.
- Risk assessment reports
- Consultation with leading safety bodies and equipment manufacturers.
- CPD delivery to specifiers and professional organisations



Protection

Automatic doors installed in the UK are subject to the highest safety demands in accordance with EN 16005:2012. To meet these requirements consideration must be given to the use of barriers, self-monitoring sensors and other protective devices. These are mandatory for each door and uniquely specific to its location.

Advanced, standards-compliant technologies for all door types:

- Compact sensors with microwave Doppler technology for motion detection
- Combination sensors with active infrared technology for simultaneous motion and passageway protection
- Active infrared motion detectors based on the triangulation principle for protection of users or obstructions located in the door panel travel path
- Laser sensors with precision monitoring and extended field of view over the door face
- Barriers, fingerguards and appropriate signage for increased risk users, children or failsafe situations



Activation

dormakaba automatic doors are designed and tested to meet a wide range of building entrance styles and user requirements. Access to the building can be controlled through a number of methods from simple switches and keylocks to intelligent access control readers.

Wide choice of access methods from dormakaba:

- Radar approach sensors, opening integrated with emergency escape systems
- Manual pushbuttons with high visibility and ease of use for disabled users.
- Access control readers using simple access fobs or fully integrated with a monitored access control system



Maintenance

Automatic doors must be maintained and periodically assessed to be safety compliant. dormakaba have the UK's largest service network of trained engineers experienced on all types of door system both dormakaba and from other manufacturers.

Qualified service engineers assessed and accredited by ADSA:

- Scheduled maintenance visits and emergency callout.
- Risk assessment reports
- Trained and accredited service engineers with national coverage and logistic support



For further advice on dormakaba products and accessories please contact:

info.gb@dormakaba.com

01462 477600



www.dormakaba.co.uk

dormakaba UK & Ireland
E: info.gb@dormakaba.com
Wilbury Way, Hitchin
Hertfordshire
SG4 0AB
T: +44(0)1462 477600
F: +44(0)1462 477601

WN 054002 51532, UK 06/2018
Subject to change without notice